

## I. Oxidation

### I.1. Introduction

Oxidation refers to the conversion of a silicon wafer's surface into silicon oxide  $SiO_2$  or  $SiO_x$ . This process is fundamental in semiconductor fabrication due to the protective and insulating properties of silicon dioxide, which provides electrical isolation and contamination resistance. Silicon's ability to form a stable oxide layer is a significant reason for its widespread use in semiconductor applications. This section introduces oxidation processes and highlights their role in integrated circuit (IC) fabrication, particularly in device isolation and surface passivation.

### I.2. Types of Oxidation

In semiconductor fabrication, oxidation typically occurs through two main mechanisms: dry oxidation and wet oxidation.

Dry and wet oxidation need high temperature (900 – 1200°C) for growth, though the kinetics are different, which is why this process is called **thermal oxidation**.

1. **Dry Oxidation** – In dry oxidation, silicon reacts directly with molecular oxygen ( $O_2$ ) at high temperatures to form  $SiO_2$ . The reaction can be expressed as:

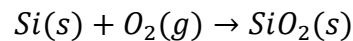

Dry oxidation produces high-quality oxide layers with minimal defects, making it suitable for applications requiring thin oxides.

2. **Wet Oxidation** – In wet oxidation, silicon reacts with water vapor ( $H_2O$ ), resulting in a faster oxidation rate due to the enhanced reactivity of steam. The chemical reaction is:

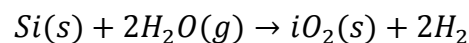

This method is often preferred for thicker oxide layers, although it may introduce structural imperfections within the oxide.

### I.3. Oxide Growth Model and Parameters

The Deal-Grove model is a widely used theoretical framework for describing the kinetics of silicon dioxide growth on silicon. This model divides oxide growth into an initial linear regime, dominated by surface reactions, and a subsequent parabolic regime where diffusion limits the growth.

**The Deal-Grove Model (see the annex)**

The oxide growth thickness  $d$  at time  $t$  is given by:

$$d^2 + A \cdot d = B(t + \tau)$$

where:

- $d$  is the oxide thickness,
- $A$  is the linear rate constant (surface reaction-limited growth),
- $B$  is the parabolic rate constant (diffusion-limited growth),
- $\tau$  represents an initial time offset, accounting for a native oxide layer.

**Parameter Derivations****1. Linear Rate Constant ( $A$ )**

The linear rate constant  $A$  depends on the reaction rate constant  $k_S$  and the gas-phase mass transfer coefficient  $h$ :

$$A = \frac{2D}{k_S + h}$$

where  $D$  is the diffusion coefficient of the oxidizing species in the oxide.

**2. Parabolic Rate Constant ( $B$ )**

The parabolic rate constant  $B$  is influenced by the diffusion of oxidizing species through the oxide and is given by:

$$B = 2DC^*/N$$

where:

- $C^*$  is the equilibrium concentration of oxidizing species in the oxide,
- $N$  is the moles of oxide formed per unit volume of silicon.

**3. Initial Time Offset ( $\tau$ )**

$\tau$  accounts for an initial oxide thickness  $d_i$ :

$$\tau = \frac{(d_i^2 + A \cdot d_i)}{B}$$

Under reaction-limited conditions (thin oxide layers), the growth rate follows a linear dependence on time:

$$d = \frac{B}{A}(t + \tau)$$

For thick oxides, where growth is diffusion-limited, the rate follows a parabolic law:

$$d^2 = Bt$$

These relationships enable predictions of oxide thickness over time, assuming equilibrium conditions.

#### I.4. Oxide Furnaces and Processing Environments

Thermal oxidation is typically performed in tube furnaces where silicon wafers are exposed to a high-temperature oxidizing atmosphere. Tube furnaces are divided into zones (source, center, load) to achieve uniform temperature and gas distribution. Vertical diffusion furnaces, commonly used for larger wafers, offer improved gas flow and temperature control, producing more uniform oxide layers. Both furnace types use filler wafers to help regulate gas flow and oxide uniformity across the wafer surface.

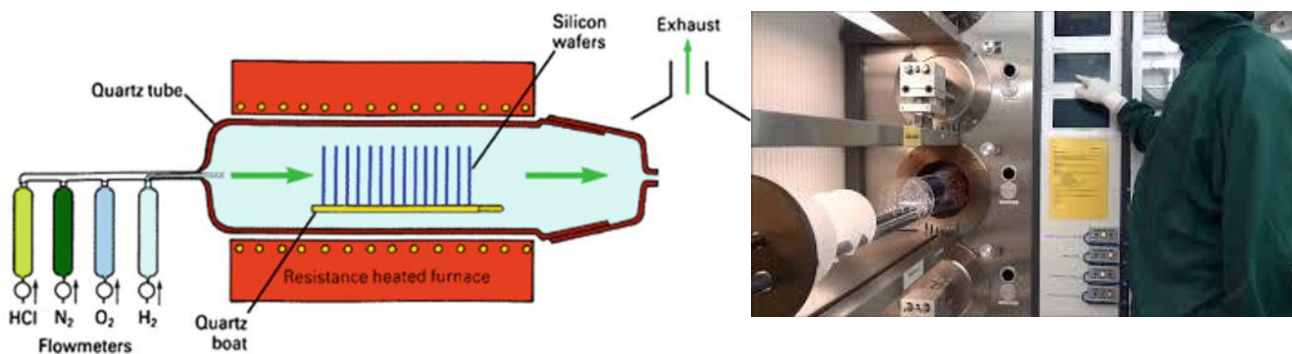

**Figure 1** thermal oxidation furnace

#### I.5. Influence of Chlorine Additives on Oxidation

Chlorine additives, such as hydrogen chloride (HCl) or trichloroethylene ( $C_2HCl_3$ ), are introduced during oxidation to improve oxide quality and reduce mobile ions. Chlorine interacts with impurities in silicon dioxide, effectively reducing their mobility and trapping them in inactive states. This reduction in mobile ions, particularly sodium ( $Na^+$ ), improves the oxide's electrical characteristics and reliability.

##### Chemical Reactions Involving Chlorine

###### 1. Chlorine and Silicon Dioxide Formation

Chlorine in the form of HCl participates in oxidation by interacting with impurities at the  $SiO_2 - Si-Si$  interface:

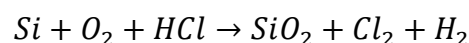

## 2. Removal of Sodium Ions ( $Na^+$ )

Sodium impurities are a common contaminant in silicon processing. Chlorine binds with sodium ions to form volatile  $NaCl$ , which is expelled from the oxide:

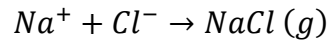

This process reduces charge traps and mobile ions at the oxide interface, enhancing device performance. Chlorine-based oxidation is especially beneficial for high-reliability applications where interface states and defect density must be minimized.

## I.6. Effects of Crystal Orientation and Pressure on Oxide Growth

The crystallographic orientation of silicon affects oxidation rates due to differences in atomic density and surface reactivity. For instance, (100) silicon planes typically exhibit slower oxidation rates than (111) planes, as the (100) orientation has a lower atomic density, resulting in fewer available silicon atoms at the interface.

### Example: Sodium ( $Na$ ) Impurities

In devices where Na impurities are present, differences in crystal orientation can impact impurity behavior. Sodium ions, which are highly mobile within the oxide, tend to accumulate differently on (100) and (111) surfaces due to variances in oxide density and defect sites associated with these orientations. On (100) planes,  $Na$  ions are less likely to migrate to the  $SiO_2 - Si$  interface, whereas on (111) planes, they may accumulate, creating charge traps that degrade electrical properties.

### Impact of Pressure

Higher pressures during oxidation increase the diffusion rate of oxidizing species, allowing for faster oxide growth. This adjustment enables more precise control over oxide thickness and uniformity. Pressure-enhanced oxidation is particularly useful for thick oxides, as it reduces oxidation time and helps maintain uniform layer properties.

## I.7. Impact of Impurities on Oxide Quality and Device Performance

Dopants and impurities in silicon substrates significantly influence oxide growth and quality. Heavily doped n-type regions, for example, exhibit faster oxidation rates due to dopant-enhanced diffusion. Phosphorus, arsenic, or antimony dopants contribute to this accelerated growth, often resulting in non-uniform oxide layers. Dopant segregation at the  $SiO_2 - Si$  interface can increase interface trap density, impacting device performance by shifting threshold voltages and reducing carrier mobility. For p-type dopants like boron, partial absorption into the oxide layer occurs, leading to depletion near the silicon surface. This section discusses impurity effects on oxide integrity and electrical characteristics, highlighting the importance of controlled doping for consistent device operation.

## I.8. Alternative Methods for Silicon Oxidation

In addition to thermal oxidation, several alternative methods have been developed for silicon oxidation, each offering unique advantages for specific applications:

### 1. Chemical Vapor Deposition (CVD)

In CVD, silicon dioxide is deposited onto the wafer surface by decomposing silicon and oxygen-containing precursors at high temperatures. Unlike thermal oxidation, CVD does not consume silicon, allowing oxide layers to be formed on various substrates without altering their dimensions. This technique is commonly used for interlayer dielectrics and planarization.

### 2. Plasma-Enhanced Chemical Vapor Deposition (PECVD)

PECVD uses a plasma to activate precursor gases at lower temperatures than traditional CVD, enabling silicon dioxide deposition on temperature-sensitive devices. PECVD provides high deposition rates and good step coverage, making it ideal for complex device geometries.

### 3. Low-Temperature Oxidation Using Nitric Acid

Ultra-thin oxides (20 nm or less) can be grown on silicon by exposing the surface to nitric acid at temperatures as low as 100 °C. This low-temperature process allows for integration with conventional lithography steps without the thermal stress associated with high-temperature oxidation, making it suitable for applications requiring minimal thermal impact.

### 4. Rapid Thermal Oxidation (RTO)

RTO uses high-temperature lamps to achieve rapid heating and cooling cycles, enabling controlled oxide growth in short time periods. This method is beneficial for producing thin oxides with minimal thermal diffusion, which is essential for advanced CMOS devices with stringent scaling requirements.

These alternative methods offer flexibility in oxide thickness, uniformity, and integration, enabling the precise tailoring of silicon oxide layers for specific device requirements.

## II Nitride Silicon ( $\text{Si}_3\text{N}_4$ )

Silicon nitride ( $\text{Si}_3\text{N}_4$ ) is a versatile material with a range of properties that make it suitable for various applications, particularly in electronics, optics, and materials science. Below is a comprehensive overview of its physical, chemical, and optical properties.

### II.1 Physical, chemical and optical properties of $\text{Si}_3\text{N}_4$

## Physical Properties

### 1. Mechanical Strength:

- Silicon nitride exhibits exceptional mechanical strength and hardness, making it resistant to wear and abrasion. It has a hardness rating of about 8.5 on the Mohs scale.
- It maintains its strength at elevated temperatures, making it suitable for high-temperature applications.

### 2. Thermal Properties:

- **Thermal Conductivity:**  $\text{Si}_3\text{N}_4$  has moderate thermal conductivity (around 20-30 W/m·K), which allows it to dissipate heat effectively.
- **Thermal Shock Resistance:** The material demonstrates excellent thermal shock resistance due to its low thermal expansion coefficient (approximately  $3.0 \times 10^{-6}/\text{K}$ ), allowing it to withstand rapid temperature changes without cracking.

### 3. Density:

- The density of silicon nitride is approximately 3.2 g/cm<sup>3</sup>, which contributes to its mechanical robustness.

### 4. Chemical Resistance:

- $\text{Si}_3\text{N}_4$  is highly resistant to oxidation and chemical corrosion, making it suitable for use in aggressive environments such as gas turbines and chemical processing equipment.

## Chemical Properties

### 1. Stoichiometry:

- Silicon nitride can exist in various stoichiometric forms (e.g.,  $\text{Si}_3\text{N}_4$ ,  $\text{Si}_2\text{N}_2\text{O}$ ) depending on the deposition method and conditions. Non-stoichiometric forms may exhibit different properties due to variations in silicon and nitrogen content.

### 2. Reactivity:

- At high temperatures,  $\text{Si}_3\text{N}_4$  can react with certain metals and form silicides or nitrides, which can be beneficial in specific applications like high-performance ceramics.

### 3. Hydrogen Content:

- Films deposited by methods like PECVD may contain hydrogen, which can affect their electrical properties and stability. The hydrogen content can be controlled through deposition parameters.

## Optical Properties

### 1. Refractive Index:

- The refractive index of silicon nitride varies with the deposition method and stoichiometry but typically ranges from 1.8 to 2.5 in the visible spectrum. For example:
  - PECVD films often have a refractive index around 1.9-2.0.
  - HWCVD films can achieve higher indices depending on the  $\text{SiH}_4/\text{NH}_3$  flow ratios.
- 2. **Transparency:**
  - Silicon nitride is transparent in the infrared range (approximately 0.2 to 5  $\mu\text{m}$ ), making it suitable for optoelectronic applications such as waveguides and photonic devices.
- 3. **Optical Band Gap:**
  - The optical band gap of  $\text{Si}_3\text{N}_4$  can vary significantly based on deposition conditions, typically ranging from about 2.43 eV to over 4 eV. This tunability allows for its use in various photonic applications.
- 4. **Absorption Coefficient:**
  - The absorption coefficient is low in the infrared range, which is advantageous for applications requiring minimal loss in optical waveguides.
- 5. **Photoluminescence:**
  - Silicon nitride films exhibit photoluminescence characteristics that depend on the deposition method and conditions, with peaks observed around 2.4 eV to 3.0 eV. This property is useful for sensing and optoelectronic devices.
- 6. **Complex Refractive Index:**
  - The complex refractive index  $n+ik$  describes both the phase velocity and absorption of light in the material, where  $n$  is the real part (refractive index) and  $k$  is the imaginary part (extinction coefficient). For  $\text{Si}_3\text{N}_4$ ,  $n$  typically ranges from 1.8 to 2.5 across different wavelengths .

### II.3 Applications in Microelectronics

In microelectronics,  $\text{Si}_3\text{N}_4$  is utilized primarily as an insulating layer in semiconductor devices. Its high dielectric strength and low leakage current make it an excellent choice for gate dielectrics in metal-oxide-semiconductor field-effect transistors (MOSFETs). Furthermore, it serves as a mask against dopants during the fabrication of integrated circuits, effectively preventing unwanted diffusion of impurities and allowing for precise patterning in the manufacturing process.

#### Advantages:

1. **High Dielectric Constant:** Provides improved capacitance in integrated circuits.
2. **Thermal Stability:** Maintains performance under high-temperature processing.
3. **Mechanical Strength:** Offers excellent mechanical integrity, crucial for device reliability.
4. **Dopant Masking:** Effectively blocks dopants, allowing for better control of doping profiles in semiconductor devices.

**Disadvantages:**

1. **Processing Challenges:** The deposition of  $\text{Si}_3\text{N}_4$  can be complex, requiring precise control of deposition parameters.
2. **Brittleness:** While strong,  $\text{Si}_3\text{N}_4$  is brittle, which can lead to cracking under mechanical stress.
3. **Limited Compatibility:** May not be compatible with all semiconductor processes, posing constraints in certain applications.

**II.4 Applications in Photovoltaics**

In photovoltaic technology, silicon nitride serves as an anti-reflective coating for solar cells, enhancing light absorption and improving overall efficiency. Its ability to reduce surface reflection allows for greater light trapping, which is critical in maximizing the energy conversion efficiency of solar cells.

In conclusion, silicon nitride is a versatile material with a range of desirable properties that make it suitable for various applications in microelectronics and photovoltaics. While it offers significant advantages, particularly in terms of thermal stability and dielectric performance, challenges related to processing and brittleness must be addressed to fully exploit its potential in these fields. The ongoing development of  $\text{Si}_3\text{N}_4$  technology continues to enhance its applicability and effectiveness in advanced electronic and energy solutions.

**II.4.1. Plasma Enhanced Chemical Vapor Deposition (PECVD)**

**Process Overview:** PECVD is a low-temperature deposition technique that uses plasma to enhance chemical reactions between gaseous precursors. The process typically operates at temperatures ranging from room temperature to  $350^\circ\text{C}$ , making it suitable for temperature-sensitive substrates. **Chemical Reactions:**

- The primary precursors for silicon nitride deposition are silane ( $\text{SiH}_4$ ) and ammonia ( $\text{NH}_3$ ). The overall reaction can be simplified as:

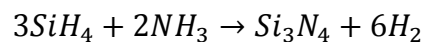

- In the plasma state, energetic electrons collide with the precursor gases, creating reactive radicals and ions that facilitate film growth.

**Physical Mechanism:**



- The PECVD system consists of two electrodes where RF energy is applied (typically at 13.56 MHz) to generate plasma. The excited species diffuse to the substrate surface, where they adsorb and react to form a silicon nitride layer.
- As the reactive species bombard the substrate, they contribute to film density and purity while also allowing for good step coverage over complex topographies.

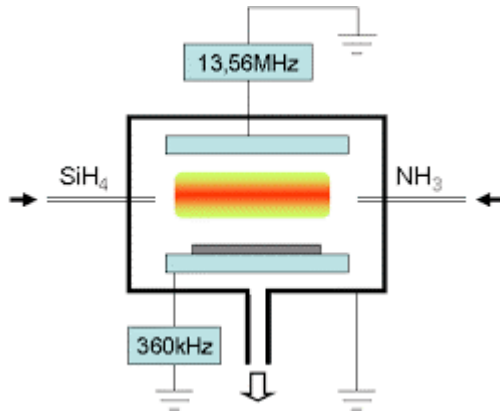

**Figure 2** Simplified schematic reactor of PECVD for depositing  $\text{Si}_3\text{N}_4$

#### Advantages:

- Low processing temperatures minimize thermal stress on substrates.
- High uniformity and control over film properties such as refractive index and mechanical stress.
- Capability to deposit conformal coatings on uneven surfaces.

#### II.4.2. Hot-Wire Chemical Vapor Deposition (HWCVD)

**Process Overview:** HWCVD utilizes a heated tungsten wire to decompose precursor gases, typically silane or dichlorosilane, which then react with nitrogen sources to form silicon nitride.

#### Chemical Reactions:

- The decomposition of silane can be represented as:

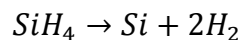

- When nitrogen is introduced, it reacts with silicon atoms to form silicon nitride:

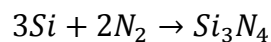

#### Physical Mechanism:

- The tungsten wire is heated to approximately  $1800^\circ\text{C}$ , creating a high-temperature environment that facilitates the decomposition of silane into silicon atoms. These atoms then migrate to the substrate where they react with nitrogen.

- HWCVD allows for precise control over film composition by adjusting gas flow rates and temperatures.

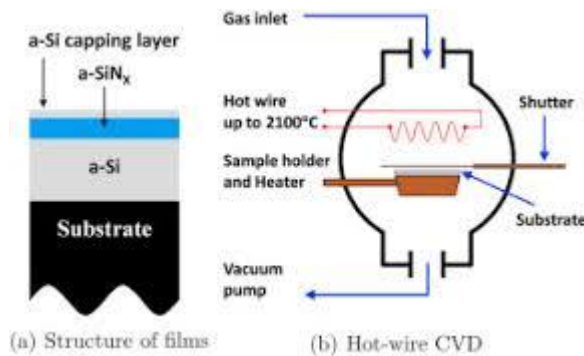

**Figure 3** Simplified schematic reactor of HWCVD for depositing Si<sub>3</sub>N<sub>4</sub>

#### Advantages:

- High deposition rates and excellent film quality.
- Ability to produce films with specific stoichiometric ratios by varying precursor concentrations.

#### II.4.3. Sputtering

**Process Overview:** Sputtering involves bombarding a silicon target with energetic ions in a vacuum chamber, causing silicon atoms to be ejected from the target and deposited onto a substrate. **Chemical Reactions:**

- The primary reaction does not involve gas-phase chemistry but rather physical ejection of silicon atoms from the target due to ion bombardment. The nitrogen gas introduced into the chamber reacts with these ejected silicon atoms:

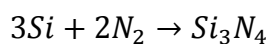

#### Physical Mechanism:

- In a typical sputtering setup, argon ions are accelerated towards the silicon target. When these ions collide with the target, they dislodge silicon atoms which then travel through the chamber and deposit on the substrate.
- This method allows for dense films with good adhesion properties.

#### Advantages:

- High-quality films with excellent uniformity.
- Capability to coat complex geometries due to line-of-sight deposition characteristics.

#### II.4.4. Laser Chemical Vapor Deposition (LCVD)

**Process Overview:** LCVD uses focused laser beams to decompose gaseous precursors directly on a substrate. **Chemical Reactions:**

- Similar to HWCVD, silane decomposes under laser irradiation:

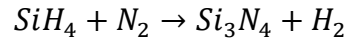

#### Physical Mechanism:

- A laser beam is focused onto the substrate surface where it provides localized heating, causing rapid decomposition of precursors. The resulting silicon atoms react with nitrogen in the gas phase to form silicon nitride.
- This method allows for precise control over film thickness and composition by adjusting laser intensity and precursor flow rates.

#### Advantages:

- High spatial resolution in film deposition.
- Ability to create complex structures due to selective heating

### II.5 Applications of Silicon Nitride ( $\text{Si}_3\text{N}_4$ ) in Integrated Circuit Fabrication

Silicon nitride is widely used in integrated circuit (IC) fabrication due to its unique properties, which make it suitable for various applications:

1. **Dielectric Layers:**  $\text{Si}_3\text{N}_4$  serves as an excellent dielectric material, providing electrical insulation between conductive layers in ICs. Its high dielectric strength and low leakage current are critical for advanced semiconductor devices.
2. **Passivation Layers:**  $\text{Si}_3\text{N}_4$  is employed as a passivation layer to protect sensitive electronic components from environmental factors such as moisture and contaminants. This enhances device reliability and longevity.
3. **Etch Stop Layers:** In multi-layer fabrication processes, silicon nitride can act as an etch stop layer, allowing for selective etching of underlying materials while preserving the integrity of the  $\text{Si}_3\text{N}_4$  layer.
4. **Optical Waveguides:** In photonic integrated circuits, silicon nitride is used to fabricate optical waveguides due to its favorable optical properties, such as low loss and high refractive index contrast with silica. This enables efficient light propagation in integrated photonic devices.
5. **Mechanical Structures:** In micro-electromechanical systems (MEMS),  $\text{Si}_3\text{N}_4$  is utilized for structural elements like beams and membranes due to its high mechanical strength and stiffness. It is often used in applications such as tunable mirrors and sensors.

6. **Thermal Barriers:** The thermal stability of silicon nitride makes it suitable for use as a thermal barrier in high-temperature applications, protecting underlying materials from thermal degradation.

## II.6 Comparison of Deposition Methods for Silicon Nitride

The following table summarizes the key characteristics, advantages, and limitations of the four primary deposition methods for silicon nitride:

Method	Process Overview	Advantages	Limitations
PECVD	Utilizes plasma to enhance chemical reactions at low temperatures.	<ul style="list-style-type: none"> <li>- Low processing temperature</li> <li>- Good conformality</li> <li>- High uniformity</li> </ul>	<ul style="list-style-type: none"> <li>- Limited deposition rates compared to HWCVD</li> <li>- Plasma-induced damage can occur</li> </ul>
HWCVD	Uses heated tungsten wire to decompose precursors.	<ul style="list-style-type: none"> <li>- High deposition rates</li> <li>- Excellent stoichiometry control</li> <li>- Good film quality</li> </ul>	<ul style="list-style-type: none"> <li>- Higher temperatures required</li> <li>- Equipment complexity</li> </ul>
Sputtering	Bombards a silicon target with ions to eject atoms for deposition.	<ul style="list-style-type: none"> <li>- Dense films with good adhesion</li> <li>- Suitable for complex geometries</li> </ul>	<ul style="list-style-type: none"> <li>- Line-of-sight deposition may limit coverage</li> <li>- Slower deposition rates</li> </ul>
LCVD	Focused laser beams decompose precursors directly on substrates.	<ul style="list-style-type: none"> <li>- High spatial resolution</li> <li>- Precise control over thickness and composition</li> </ul>	<ul style="list-style-type: none"> <li>- Equipment cost can be high</li> <li>- Limited scalability</li> </ul>

## II.7 Quality and Structure of Silicon Nitride Layers Deposited by Different Methods

The quality of silicon nitride ( $\text{Si}_3\text{N}_4$ ) films and their structural characteristics (amorphous, polycrystalline, or crystalline) vary significantly depending on the deposition method used. Below is a comparison table summarizing these aspects for the four primary deposition techniques discussed previously.

Method	Quality of Deposited Layer	Structure Type	Temperature Interval (°C)
Plasma Enhanced Chemical Vapor Deposition (PECVD)	<ul style="list-style-type: none"> <li>- High quality with low impurity levels</li> <li>- Uniform thickness</li> <li>- Good dielectric properties</li> <li>- Low roughness</li> </ul>	Amorphous	50 to 400
Hot-Wire Chemical Vapor Deposition (HWCVD)	<ul style="list-style-type: none"> <li>- High-quality films with controllable stoichiometry</li> <li>- Low hydrogen content</li> <li>- Good mechanical properties</li> </ul>	Amorphous to slightly crystalline	200 to 800
Sputtering	<ul style="list-style-type: none"> <li>- Dense films with good adhesion</li> <li>- Generally lower uniformity compared to PECVD</li> <li>- Higher impurity levels if not controlled properly</li> </ul>	Amorphous	200 to 600
Laser Chemical Vapor Deposition (LCVD)	<ul style="list-style-type: none"> <li>- High spatial resolution with precise thickness control</li> <li>- Can achieve high-quality films suitable for photonic applications</li> </ul>	Typically amorphous or nanocrystalline	200 to 800

### Detailed Descriptions

#### 1. Plasma Enhanced Chemical Vapor Deposition (PECVD):

- **Quality:** Films deposited using PECVD exhibit high quality with low levels of impurities and uniform thickness. They also possess excellent dielectric properties, making them suitable for various electronic applications.
- **Structure:** The deposited layers are primarily amorphous, which contributes to their electrical insulation properties.
- **Temperature Interval:** Typically operates between **50°C and 400°C**, allowing for deposition on temperature-sensitive substrates.
- **Applications:** Ideal for low-temperature processes where conformal coatings are needed, such as in MEMS and photonic devices.

#### 2. Hot-Wire Chemical Vapor Deposition (HWCVD):

- **Quality:** HWCVD produces high-quality silicon nitride films with controlled stoichiometry and low hydrogen content, leading to improved mechanical properties.
- **Structure:** The structure can vary from amorphous to slightly crystalline depending on the deposition parameters.

- **Temperature Interval:** Operates at higher temperatures, typically between **200°C and 800°C**, which can enhance film quality but may limit substrate compatibility.
  - **Applications:** Suitable for applications requiring high-quality films with controlled stoichiometry, such as advanced semiconductor devices.
3. **Sputtering:**
- **Quality:** Sputtered  $\text{Si}_3\text{N}_4$  films are dense and have good adhesion but may exhibit lower uniformity compared to PECVD films. Careful control of deposition conditions is necessary to minimize impurities.
  - **Structure:** Typically results in amorphous layers, which are beneficial for certain applications but may limit optical performance in photonic devices.
  - **Temperature Interval:** Generally performed at temperatures ranging from **200°C to 600°C**.
  - **Applications:** Commonly used for dense dielectric layers in ICs due to its excellent adhesion properties.
4. **Laser Chemical Vapor Deposition (LCVD):**
- **Quality:** LCVD allows for high spatial resolution in film deposition, achieving high-quality films suitable for advanced photonic applications.
  - **Structure:** The resulting films can be amorphous or nanocrystalline based on the specific laser parameters used during deposition.
  - **Temperature Interval:** Operates over a wide range from **200°C to 800°C**, providing flexibility in processing conditions.
  - **Applications:** Useful for applications requiring precise control over film properties and thickness, such as photonic integrated circuits.

The quality of silicon nitride ( $\text{Si}_3\text{N}_4$ ) films and their structural characteristics (amorphous, polycrystalline, or crystalline) vary significantly depending on the deposition method used. Below is a comparison table summarizing these aspects for the four primary deposition techniques discussed previously.

The choice of deposition method for silicon nitride significantly influences both the quality and structural characteristics of the resulting films. PECVD is favored for its high quality and uniformity in dielectric applications, while HWCVD excels in mechanical properties and stoichiometry control. Sputtering provides dense films with good adhesion but requires careful impurity management, whereas LCVD allows for precise spatial control at the potential cost of increased impurities. Understanding these differences is essential for selecting the appropriate method based on application-specific requirements in integrated circuit fabrication.